

Lay-In Wireway Type 1 Quick-Connect Hinge Cover Data Sheet

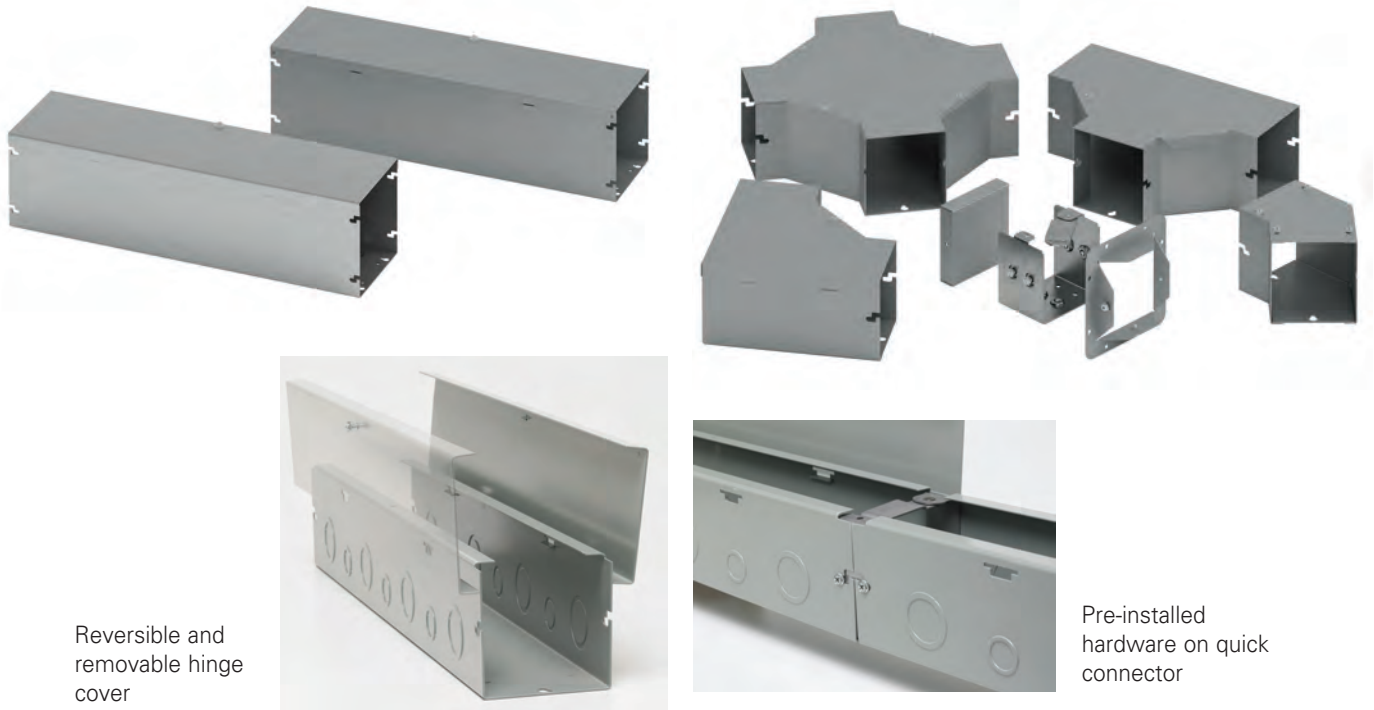

Reversible and removable hinge cover

Pre-installed hardware on quick connector

Application

- Houses runs of control and power cable
- Used for cable and wire junction, distribution and termination

Standards

- UL 870 listed, Type 1
- CSA C22.2 No. 26 certified, Type 1
- Conforms to NEMA standard for Type 1

Finish

- Wash and phosphate undercoat
- ANSI 61 gray acrylic electrocoat finish

Accessories

- Touch-up paint
- See Accessories section

Protected by U.S. Patents 7,525,044 & 7,762,042

Construction

- Wireway body and cover are fabricated from code gauge steel, (see table, page 16)
- Wireway body has mounting holes on the back
- Wireway is available with or without knockouts
- Wireway fittings have no knockouts, ends are available with or without knockouts
- Wireway exceeding 72 inches in length has two overlapping covers
- Variety of fittings allow runs which can change directions, junction and terminate
- Wireway connectors (sold separately) have a gate feature which can swing completely open allowing for lay-in of wire and cable
- Universal style connectors are also available for adapting to other manufacturer's wireway, (see page 17)
- Except for wireway ends, completely interchangeable with Type 1 screw cover wireway and fittings through use of the adapter style connector HSCA, (see page 17)

Discount Schedule: A2

Subclass: HS1

Notes: We can provide special sizes, finishes and other modifications. Consult the factory for your special requirements.

Lay-In Wireway Type 1 Quick-Connect Hinge Cover Illustration Sheet and Catalog Number

Subclass: HS1

Wireway Catalog Number		Wireway Size Height x Depth x Length		D		Gauge	Knockout Quantity	
KO	No KO	A x B x C		in.	mm		Top	Bottom
2212 HS	2212 HS NK	2.50 x 2.50 x 12.00	63 x 63 x 305	1.25	32	16	3	3
2224 HS	2224 HS NK	2.50 x 2.50 x 24.00	63 x 63 x 610	1.25	32	16	7	7
2236 HS	2236 HS NK	2.50 x 2.50 x 36.00	63 x 63 x 914	1.25	32	16	11	11
2248 HS	2248 HS NK	2.50 x 2.50 x 48.00	63 x 63 x 1219	1.25	32	16	15	15
2260 HS	2260 HS NK	2.50 x 2.50 x 60.00	63 x 63 x 1524	1.25	32	16	19	19
2272 HS	2272 HS NK	2.50 x 2.50 x 72.00	63 x 63 x 1829	1.25	32	16	23	23
22120 HS	22120 HS NK	2.50 x 2.50 x 120.00	63 x 63 x 3048	1.25	32	16	39	39
4412 HS	4412 HS NK	4.00 x 4.00 x 12.00	102 x 102 x 305	2.75	70	16	3	3
4424 HS	4424 HS NK	4.00 x 4.00 x 24.00	102 x 102 x 610	2.75	70	16	7	7
4436 HS	4436 HS NK	4.00 x 4.00 x 36.00	102 x 102 x 914	2.75	70	16	11	11
4448 HS	4448 HS NK	4.00 x 4.00 x 48.00	102 x 102 x 1219	2.75	70	16	15	15
4460 HS	4460 HS NK	4.00 x 4.00 x 60.00	102 x 102 x 1524	2.75	70	16	19	19
4472 HS	4472 HS NK	4.00 x 4.00 x 72.00	102 x 102 x 1829	2.75	70	16	23	23
44120 HS	44120 HS NK	4.00 x 4.00 x 120.00	102 x 102 x 3048	2.75	70	16	39	39
6612 HS	6612 HS NK	6.00 x 6.00 x 12.00	152 x 152 x 305	4.25	108	16	3	3
6624 HS	6624 HS NK	6.00 x 6.00 x 24.00	152 x 152 x 610	4.25	108	16	7	7
6636 HS	6636 HS NK	6.00 x 6.00 x 36.00	152 x 152 x 914	4.25	108	16	11	11
6648 HS	6648 HS NK	6.00 x 6.00 x 48.00	152 x 152 x 1219	4.25	108	16	15	15
6660 HS	6660 HS NK	6.00 x 6.00 x 60.00	152 x 152 x 1524	4.25	108	16	19	19
6672 HS	6672 HS NK	6.00 x 6.00 x 72.00	152 x 152 x 1829	4.25	108	16	23	23
66120 HS	66120 HS NK	6.00 x 6.00 x 120.00	152 x 152 x 3048	4.25	108	16	39	39
8812 HS	8812 HS NK	8.00 x 8.00 x 12.00	203 x 203 x 305	6.00	152	14	3	3
8824 HS	8824 HS NK	8.00 x 8.00 x 24.00	203 x 203 x 610	6.00	152	14	7	7
8836 HS	8836 HS NK	8.00 x 8.00 x 36.00	203 x 203 x 914	6.00	152	14	11	11
8848 HS	8848 HS NK	8.00 x 8.00 x 48.00	203 x 203 x 1219	6.00	152	14	15	15
8860 HS	8860 HS NK	8.00 x 8.00 x 60.00	203 x 203 x 1524	6.00	152	14	19	19
8872 HS	8872 HS NK	8.00 x 8.00 x 72.00	203 x 203 x 1829	6.00	152	14	23	23
88120 HS	88120 HS NK	8.00 x 8.00 x 120.00	203 x 203 x 3048	6.00	152	14	39	39
101012 HS	101012 HS NK	10.00 x 10.00 x 12.00	254 x 254 x 305	8.00	203	14	3	3
101024 HS	101024 HS NK	10.00 x 10.00 x 24.00	254 x 254 x 610	8.00	203	14	7	7
101036 HS	101036 HS NK	10.00 x 10.00 x 36.00	254 x 254 x 914	8.00	203	14	11	11
101048 HS	101048 HS NK	10.00 x 10.00 x 48.00	254 x 254 x 1219	8.00	203	14	15	15
101060 HS	101060 HS NK	10.00 x 10.00 x 60.00	254 x 254 x 1524	8.00	203	14	19	19
1010120 HS	1010120 HS NK	10.00 x 10.00 x 120.00	254 x 254 x 3048	8.00	203	14	39	39
121212 HS	121212 HS NK	12.00 x 12.00 x 12.00	305 x 305 x 305	10.00	254	14	3	3
121224 HS	121224 HS NK	12.00 x 12.00 x 24.00	305 x 305 x 610	10.00	254	14	7	7
121236 HS	121236 HS NK	12.00 x 12.00 x 36.00	305 x 305 x 914	10.00	254	14	11	11
121248 HS	121248 HS NK	12.00 x 12.00 x 48.00	305 x 305 x 1219	10.00	254	14	15	15
121260 HS	121260 HS NK	12.00 x 12.00 x 60.00	305 x 305 x 1524	10.00	254	14	19	19
1212120 HS	1212120 HS NK	12.00 x 12.00 x 120.00	305 x 305 x 3048	10.00	254	14	39	39

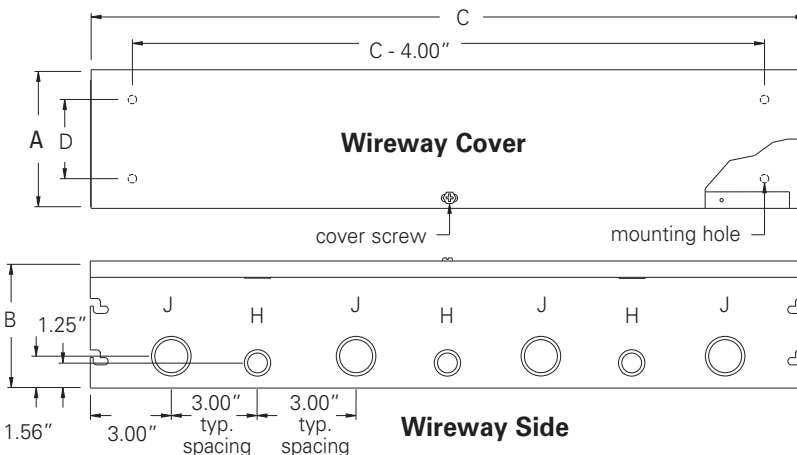

Wireway Section

Lengths from 12.00" (305 mm) to 120.00" (305 mm). Wireway exceeding 72.00" (1829 mm) has two covers. Shown with KO's, also available without.

Knockout sizes:
H = 3/4" or 1/2" conduit
J = 1 1/4" or 1" conduit

Notes: Additional mounting holes are furnished when C dimension is over 60.00" (1524 mm).

Dimensions are in inches. Millimeters shown are for reference only. Data subject to change without notice.

Lay-In Wireway Type 1 Quick-Connect Hinge Cover Illustration Sheet and Catalog Number

Subclass: HS1

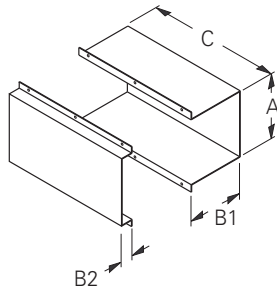

Telescopic Fitting

Adjustable length up to 10.00" (254 mm). Wraps around the two near joining wireway lengths to achieve a continuous run.

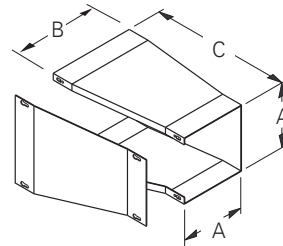

Reducer

B dimensions (see catalog table), correspond to the large end opening. Used to reduce or enlarge wireway runs. Removable cover is secured with screws.

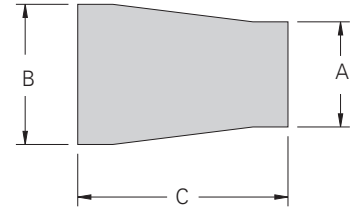

Catalog Number	A		B1		B2		C	
	in.	mm	in.	mm	in.	mm	in.	mm
22 FTF	2.75	70	1.75	44	1.12	28	12.00	305
33FTF	3.25	83	2.25	57	1.12	28	12.00	305
44 FTF	4.25	108	3.25	83	1.12	28	12.00	305
66 FTF	6.25	159	5.25	133	1.12	28	12.00	305
88 FTF	8.25	210	7.25	184	1.12	28	12.00	305
1010 FTF	10.25	260	9.25	235	1.12	28	12.00	305
1212 FTF	12.25	311	11.25	286	1.12	28	12.00	305

Catalog Number	A		B		C	
	in.	mm	in.	mm	in.	mm
2233 FR *	2.50	63	3.00	76	6.00	152
3344 FR *	3.00	76	4.00	102	8.00	203
4466 FR *	4.00	102	6.00	152	10.00	254
6688 FR *	6.00	152	8.00	203	12.00	305
881010 FR *	8.00	203	10.00	254	12.00	305
10101212 FR *	10.00	254	12.00	305	16.00	406

* Requires use of HSCA Adapter Style Connector.

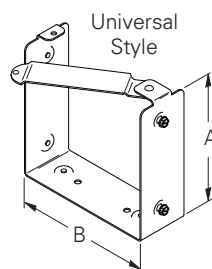
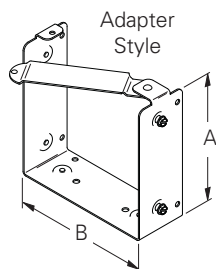
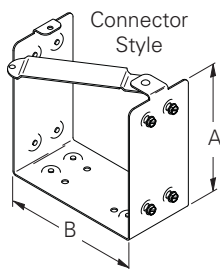

Connector

Swing gate allows for lay-in of wire and cable.

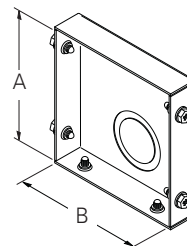

End

Used to terminate wireway or fitting. Shown with KO, also available without.

Drawing shows screws in place. Screws are actually packaged in plastic bags.

Connector			A		B	
Connector Style	Adapter Style	Universal Style	in.	mm	in.	mm
22 HSC	22 HSCA	22 HSCU	2.50	63	2.50	63
44 HSC	44 HSCA	44 HSCU	4.00	102	4.00	102
66 HSC	66 HSCA	66 HSCU	6.00	152	6.00	152
88 HSC	88 HSCA	88 HSCU	8.00	203	8.00	203
1010 HSC	1010 HSCA	1010 HSCU	10.00	254	10.00	254
1212 HSC	1212 HSCA	1212 HSCU	12.00	305	12.00	305

HSC - Standard Quick Connector
HSCA - For adapting to Type 1 Screw Cover Wireway
HSCU - For adapting to competitive Wireway

End			A		B		KO	
Catalog Number KO	Catalog Number No KO		in.	mm	in.	mm	in.	mm
22 HSE	22 HSE NK		2.50	63	2.50	63	1.50	38
44 HSE	44 HSE NK		4.00	102	4.00	102	1.50	38
66 HSE	66 HSE NK		6.00	152	6.00	152	1.50	38
88 HSE	88 HSE NK		8.00	203	8.00	203	1.50	38
1010 HSE	1010 HSE NK		10.00	254	10.00	254	3.00	76
1212 HSE	1212 HSE NK		12.00	305	12.00	305	3.00	76

Notes: Dimensions are in inches. Millimeters shown are for reference only. Data subject to change without notice.

Lay-In Wireway Type 1 Quick-Connect Hinge Cover Illustration Sheet and Catalog Number

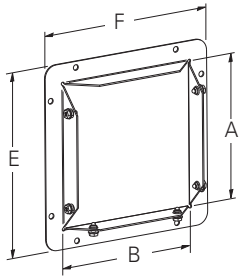

Wireway End Flange

Allows for a secure connection of wireway to an adjoining enclosure or wall.

Wireway End Flange

Catalog Number	A		B		E		F	
	in.	mm	in.	mm	in.	mm	in.	mm
22 HSF	2.50	63	2.50	63	4.00	102	4.00	102
44 HSF	4.00	102	4.00	102	5.50	140	5.50	140
66 HSF	6.00	152	6.00	152	7.50	191	7.50	191
88 HSF	8.00	203	8.00	203	9.50	241	9.50	241
1010 HSF	10.00	254	10.00	254	11.50	292	11.50	292
1212 HSF	12.00	305	12.00	305	13.50	343	13.50	343

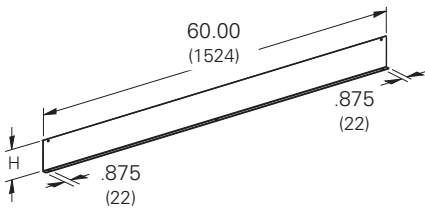

Barrier, Bolt-On

For those installations that require separate wiring compartments.

Barrier Kit, 60" Bolt-On

Catalog Number	Size		Length		H	
	in.	mm	in.	mm	in.	mm
22-12BK*	2.50 x 2.50	64 x 64	60.00	1524	1.88	48
33-12BK*	3.00 x 3.00	76 x 76	60.00	1524	2.25	57
44-12BK*	4.00 x 4.00	102 x 102	60.00	1524	3.00	76
66-12BK*	6.00 x 6.00	152 x 152	60.00	1524	4.50	114
88-12BK*	8.00 x 8.00	203 x 203	60.00	1524	6.00	152
1010-12BK*	10.00 x 10.00	254 x 254	60.00	1524	8.00	203
1212-12BK*	12.00 x 12.00	305 x 305	60.00	1524	10.50	267

*Not UL or CSA listed fitting.

Subclass: HS1

Wireway Hangers

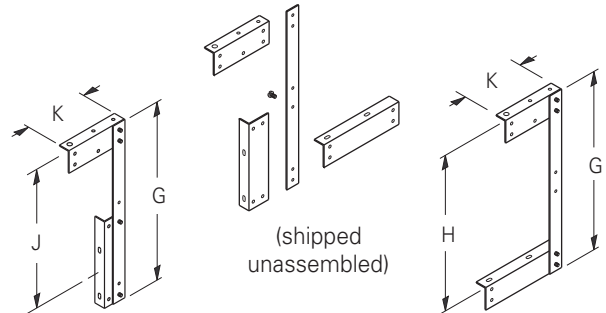

(shipped unassembled)

Side Cover Assembly

For those installations where the wireway cover must be hinged at the side.

Top Cover Assembly

For those installations where the wireway cover must be hinged at the top.

Wireway Hanger

Catalog Number	G		H		J		K	
	in.	mm	in.	mm	in.	mm	in.	mm
22 FH	8.50	216	8.50	216	6.50	165	2.87	73
44 FH	12.50	318	10.50	267	10.37	263	4.87	121
66 FH	16.50	419	14.50	394	13.50	340	5.87	146
88 FH	20.50	521	18.50	495	16.75	425	6.87	171
1010 FH **	24.50	622	22.50	571	17.25	438	7.87	200
1212 FH **	28.50	724	26.50	673	20.25	514	8.87	225

** Hangers are shipped welded in the top cover assembly position.

Notes: Dimensions are in inches. Millimeters shown are for reference only. Data subject to change without notice.

Lay-In Wireway Type 1 Quick-Connect Hinge Cover Illustration Sheet and Catalog Number

Subclass: HS1

Wireway 90° Elbows

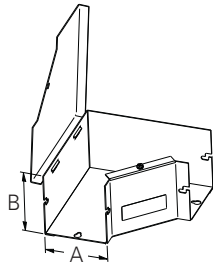
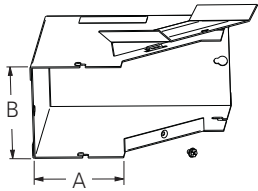

Inside Opening

Specifically designed to have only the inside cover hinge open to allow a continuous run with 90° turns.

Side Opening

Side cover is hinged to allow a continuous run on designs with 90° sweeping turns.

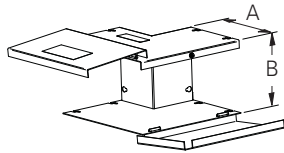

Outside Opening

Specifically designed to have the outside covers hinge open to allow a continuous run with 90° turns.

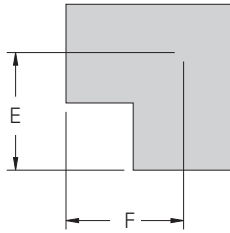

(outside opening)

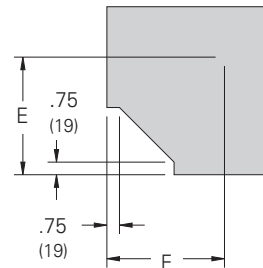

(inside and side opening)

Catalog Number	A		B		E		F	
	in.	mm	in.	mm	in.	mm	in.	mm
22 HSL IN	2.50	63	2.50	63	3.31	84	3.31	84
44 HSL IN	4.00	102	4.00	102	4.06	103	4.06	103
66 HSL IN	6.00	152	6.00	152	5.06	128	5.06	128
88 HSL IN	8.00	203	8.00	203	6.06	154	6.06	154
1010 HSL IN	10.00	254	10.00	254	7.06	179	7.06	179
1212 HSL IN	12.00	305	12.00	305	8.06	205	8.06	205
22 HSL OUT	2.50	63	2.50	63	3.38	86	3.38	86
44 HSL OUT	4.00	102	4.00	102	4.09	104	4.09	104
66 HSL OUT	6.00	152	6.00	152	5.09	129	5.09	129
88 HSL OUT	8.00	203	8.00	203	6.09	154	6.09	154
1010 HSL OUT	10.00	254	10.00	254	7.09	180	7.09	180
1212 HSL OUT	12.00	305	12.00	305	8.09	205	8.09	205
22 HSL SIDE	2.50	63	2.50	63	3.50	89	3.50	89
44 HSL SIDE	4.00	102	4.00	102	4.32	110	4.32	110
66 HSL SIDE	6.00	152	6.00	152	5.31	135	5.31	135
88 HSL SIDE	8.00	203	8.00	203	6.31	160	6.31	160
1010 HSL SIDE	10.00	254	10.00	254	7.31	185	7.31	185
1212 HSL SIDE	12.00	305	12.00	305	8.31	211	8.31	211

Wireway 45° Elbows

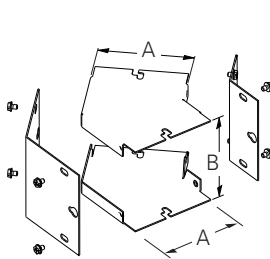

Combo Opening

Designed to achieve a 45° turn. Inside and outside removable covers are secured with screws.

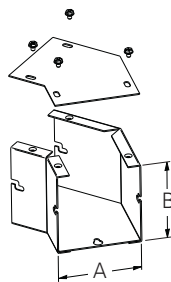

Side Opening

Designed to achieve a 45° turn and have the cover removed from the side. Excellent for combining two to make a gradual 90° sweep.

Catalog Number	A		B		E		F	
	in.	mm	in.	mm	in.	mm	in.	mm
2245 HSL COMBO	2.50	63	2.50	63	1.72	43	1.72	43
4445 HSL COMBO	4.00	102	4.00	102	2.75	70	2.75	70
6645 HSL COMBO	6.00	152	6.00	152	3.18	81	3.18	81
8845 HSL COMBO	8.00	203	8.00	203	3.62	92	3.62	92
101045 HSL COMBO	10.00	254	10.00	254	4.06	103	4.06	103
121245 HSL COMBO	12.00	305	12.00	305	4.50	114	4.50	114
2245 HSL SIDE	2.50	63	2.50	63	1.72	43	1.72	43
4445 HSL SIDE	4.00	102	4.00	102	2.75	70	2.75	70
6645 HSL SIDE	6.00	152	6.00	152	3.18	81	3.18	81
8845 HSL SIDE	8.00	203	8.00	203	3.62	92	3.62	92
101045 HSL SIDE	10.00	254	10.00	254	4.06	103	4.06	103
121245 HSL SIDE	12.00	305	12.00	254	4.50	114	4.50	114

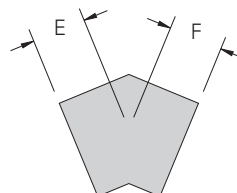

Notes: Dimensions are in inches. Millimeters shown are for reference only. Data subject to change without notice.

Lay-In Wireway Type 1 Quick-Connect Hinge Cover Illustration Sheet and Catalog Number

Subclass: HS1

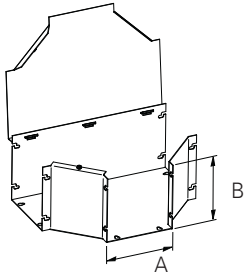

Tee
Side hinge cover design for applications where a "T" junction is necessary.

Catalog Number	A		B		E		F	
	in.	mm	in.	mm	in.	mm	in.	mm
22 HST	2.50	63	2.50	63	5.38	136	4.25	198
44 HST	4.00	102	4.00	102	6.15	156	6.12	155
66 HST	6.00	152	6.00	152	7.15	181	7.12	181
88 HST	8.00	203	8.00	203	8.15	207	8.12	206
1010 HST	10.00	254	10.00	254	9.15	232	9.12	231
1212 HST	12.00	305	12.00	305	10.15	258	10.12	257

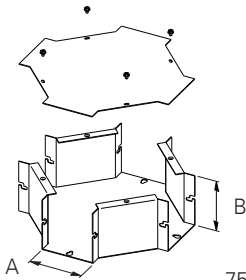
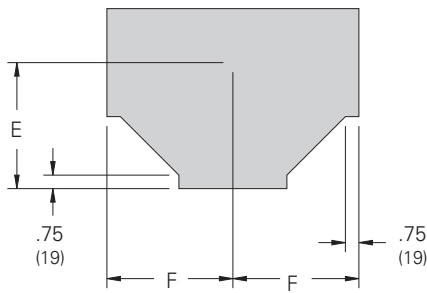

Cross
Side cover and broad body design to junction cable run in four directions. Removable cover is secured with screws.

Catalog Number	A		B		E		F	
	in.	mm	in.	mm	in.	mm	in.	mm
22 HSX	2.50	63	2.50	63	5.97	151	5.97	151
44 HSX	4.00	102	4.00	102	6.75	171	6.75	171
66 HSX	6.00	152	6.00	152	7.75	197	7.75	197
88 HSX	8.00	203	8.00	203	8.75	222	8.75	222
1010 HSX	10.00	254	10.00	254	9.75	247	9.75	247
1212 HSX	12.00	305	12.00	305	10.75	273	10.75	273

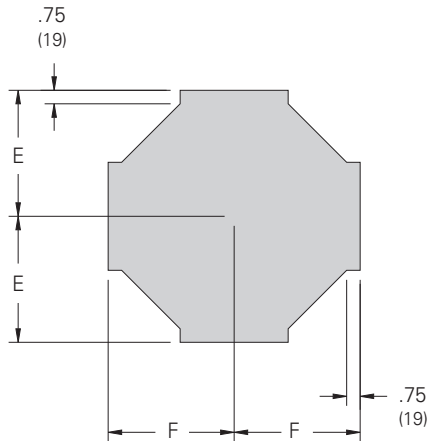

Notes: Dimensions are in inches. Millimeters shown are for reference only. Data subject to change without notice.

Lay-In Wireway Type 1 Quick-Connect Hinge Cover Data Sheet

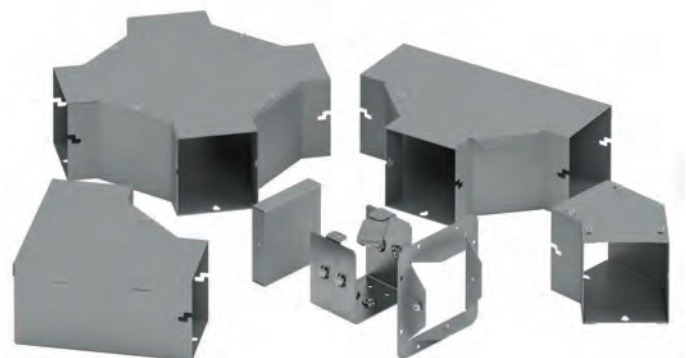
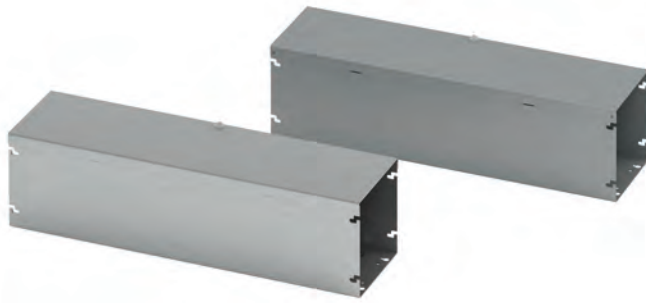

Reversible and removable hinge cover



Pre-installed hardware on quick connector

Application

- Houses runs of control and power cable
- Used for cable and wire junction, distribution and termination

Standards

- UL 870 listed, Type 1
- CSA C22.2 No. 26 certified, Type 1
- Conforms to NEMA standard for Type 1

Finish

- Wash and phosphate undercoat
- ANSI 61 gray acrylic electrocoat finish

Accessories

- Touch-up paint
- See Accessories section

Protected by U.S. Patents 7,525,044 & 7,762,042

Construction

- Wireway body and cover are fabricated from code gauge steel, (see table, page 16)
- Wireway body has mounting holes on the back
- Wireway is available with or without knockouts
- Wireway fittings have no knockouts, ends are available with or without knockouts
- Wireway exceeding 72 inches in length has two overlapping covers
- Variety of fittings allow runs which can change directions, junction and terminate
- Wireway connectors (sold separately) have a gate feature which can swing completely open allowing for lay-in of wire and cable
- Universal style connectors are also available for adapting to other manufacturer's wireway, (see page 17)
- Except for wireway ends, completely interchangeable with Type 1 screw cover wireway and fittings through use of the adapter style connector HSCA, (see page 17)

Discount Schedule: A2

Subclass: HS1

Notes: We can provide special sizes, finishes and other modifications. Consult the factory for your special requirements.

Lay-In Wireway Type 1 Quick-Connect Hinge Cover Illustration Sheet and Catalog Number

Subclass: HS1

Wireway Catalog Number		Wireway Size Height x Depth x Length		D		Gauge	Knockout Quantity	
KO	No KO	A x B x C		in.	mm		Top	Bottom
2212 HS	2212 HS NK	2.50 x 2.50 x 12.00	63 x 63 x 305	1.25	32	16	3	3
2224 HS	2224 HS NK	2.50 x 2.50 x 24.00	63 x 63 x 610	1.25	32	16	7	7
2236 HS	2236 HS NK	2.50 x 2.50 x 36.00	63 x 63 x 914	1.25	32	16	11	11
2248 HS	2248 HS NK	2.50 x 2.50 x 48.00	63 x 63 x 1219	1.25	32	16	15	15
2260 HS	2260 HS NK	2.50 x 2.50 x 60.00	63 x 63 x 1524	1.25	32	16	19	19
2272 HS	2272 HS NK	2.50 x 2.50 x 72.00	63 x 63 x 1829	1.25	32	16	23	23
22120 HS	22120 HS NK	2.50 x 2.50 x 120.00	63 x 63 x 3048	1.25	32	16	39	39
4412 HS	4412 HS NK	4.00 x 4.00 x 12.00	102 x 102 x 305	2.75	70	16	3	3
4424 HS	4424 HS NK	4.00 x 4.00 x 24.00	102 x 102 x 610	2.75	70	16	7	7
4436 HS	4436 HS NK	4.00 x 4.00 x 36.00	102 x 102 x 914	2.75	70	16	11	11
4448 HS	4448 HS NK	4.00 x 4.00 x 48.00	102 x 102 x 1219	2.75	70	16	15	15
4460 HS	4460 HS NK	4.00 x 4.00 x 60.00	102 x 102 x 1524	2.75	70	16	19	19
4472 HS	4472 HS NK	4.00 x 4.00 x 72.00	102 x 102 x 1829	2.75	70	16	23	23
44120 HS	44120 HS NK	4.00 x 4.00 x 120.00	102 x 102 x 3048	2.75	70	16	39	39
6612 HS	6612 HS NK	6.00 x 6.00 x 12.00	152 x 152 x 305	4.25	108	16	3	3
6624 HS	6624 HS NK	6.00 x 6.00 x 24.00	152 x 152 x 610	4.25	108	16	7	7
6636 HS	6636 HS NK	6.00 x 6.00 x 36.00	152 x 152 x 914	4.25	108	16	11	11
6648 HS	6648 HS NK	6.00 x 6.00 x 48.00	152 x 152 x 1219	4.25	108	16	15	15
6660 HS	6660 HS NK	6.00 x 6.00 x 60.00	152 x 152 x 1524	4.25	108	16	19	19
6672 HS	6672 HS NK	6.00 x 6.00 x 72.00	152 x 152 x 1829	4.25	108	16	23	23
66120 HS	66120 HS NK	6.00 x 6.00 x 120.00	152 x 152 x 3048	4.25	108	16	39	39
8812 HS	8812 HS NK	8.00 x 8.00 x 12.00	203 x 203 x 305	6.00	152	14	3	3
8824 HS	8824 HS NK	8.00 x 8.00 x 24.00	203 x 203 x 610	6.00	152	14	7	7
8836 HS	8836 HS NK	8.00 x 8.00 x 36.00	203 x 203 x 914	6.00	152	14	11	11
8848 HS	8848 HS NK	8.00 x 8.00 x 48.00	203 x 203 x 1219	6.00	152	14	15	15
8860 HS	8860 HS NK	8.00 x 8.00 x 60.00	203 x 203 x 1524	6.00	152	14	19	19
8872 HS	8872 HS NK	8.00 x 8.00 x 72.00	203 x 203 x 1829	6.00	152	14	23	23
88120 HS	88120 HS NK	8.00 x 8.00 x 120.00	203 x 203 x 3048	6.00	152	14	39	39
101012 HS	101012 HS NK	10.00 x 10.00 x 12.00	254 x 254 x 305	8.00	203	14	3	3
101024 HS	101024 HS NK	10.00 x 10.00 x 24.00	254 x 254 x 610	8.00	203	14	7	7
101036 HS	101036 HS NK	10.00 x 10.00 x 36.00	254 x 254 x 914	8.00	203	14	11	11
101048 HS	101048 HS NK	10.00 x 10.00 x 48.00	254 x 254 x 1219	8.00	203	14	15	15
101060 HS	101060 HS NK	10.00 x 10.00 x 60.00	254 x 254 x 1524	8.00	203	14	19	19
1010120 HS	1010120 HS NK	10.00 x 10.00 x 120.00	254 x 254 x 3048	8.00	203	14	39	39
121212 HS	121212 HS NK	12.00 x 12.00 x 12.00	305 x 305 x 305	10.00	254	14	3	3
121224 HS	121224 HS NK	12.00 x 12.00 x 24.00	305 x 305 x 610	10.00	254	14	7	7
121236 HS	121236 HS NK	12.00 x 12.00 x 36.00	305 x 305 x 914	10.00	254	14	11	11
121248 HS	121248 HS NK	12.00 x 12.00 x 48.00	305 x 305 x 1219	10.00	254	14	15	15
121260 HS	121260 HS NK	12.00 x 12.00 x 60.00	305 x 305 x 1524	10.00	254	14	19	19
1212120 HS	1212120 HS NK	12.00 x 12.00 x 120.00	305 x 305 x 3048	10.00	254	14	39	39

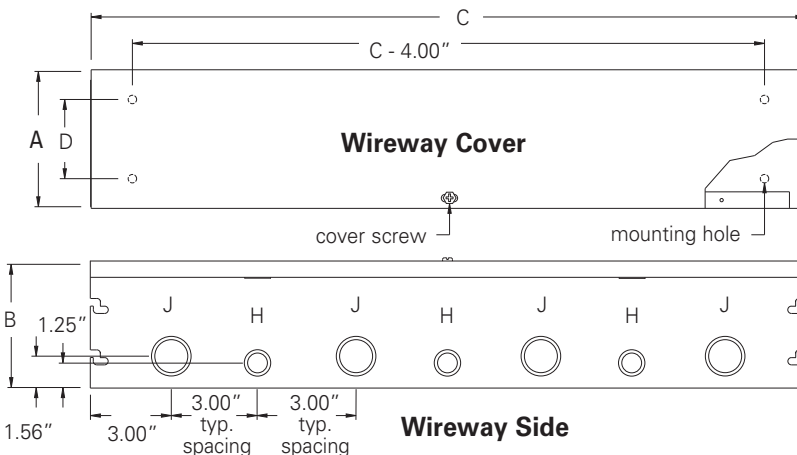

Wireway Section

Lengths from 12.00" (305 mm) to 120.00" (305 mm). Wireway exceeding 72.00" (1829 mm) has two covers. Shown with KO's, also available without.

Knockout sizes:
H = 3/4" or 1/2" conduit
J = 1 1/4" or 1" conduit

Notes: Additional mounting holes are furnished when C dimension is over 60.00" (1524 mm).

Dimensions are in inches. Millimeters shown are for reference only. Data subject to change without notice.

Lay-In Wireway Type 1 Quick-Connect Hinge Cover Illustration Sheet and Catalog Number

Subclass: HS1

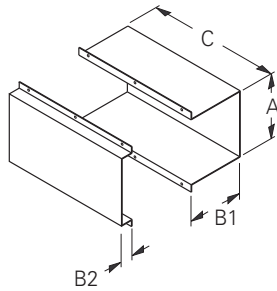

Telescopic Fitting

Adjustable length up to 10.00" (254 mm). Wraps around the two near joining wireway lengths to achieve a continuous run.

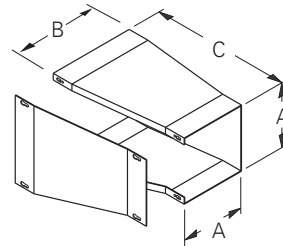

Reducer

B dimensions (see catalog table), correspond to the large end opening. Used to reduce or enlarge wireway runs. Removable cover is secured with screws.

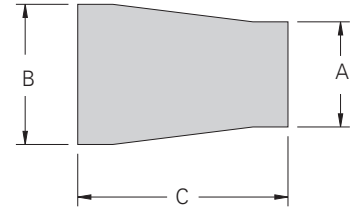

Telescopic Fitting

Catalog Number	A		B1		B2		C	
	in.	mm	in.	mm	in.	mm	in.	mm
22 FTF	2.75	70	1.75	44	1.12	28	12.00	305
33FTF	3.25	83	2.25	57	1.12	28	12.00	305
44 FTF	4.25	108	3.25	83	1.12	28	12.00	305
66 FTF	6.25	159	5.25	133	1.12	28	12.00	305
88 FTF	8.25	210	7.25	184	1.12	28	12.00	305
1010 FTF	10.25	260	9.25	235	1.12	28	12.00	305
1212 FTF	12.25	311	11.25	286	1.12	28	12.00	305

Reducer

Catalog Number	A		B		C	
	in.	mm	in.	mm	in.	mm
2233 FR *	2.50	63	3.00	76	6.00	152
3344 FR *	3.00	76	4.00	102	8.00	203
4466 FR *	4.00	102	6.00	152	10.00	254
6688 FR *	6.00	152	8.00	203	12.00	305
881010 FR *	8.00	203	10.00	254	12.00	305
10101212 FR *	10.00	254	12.00	305	16.00	406

* Requires use of HSCA Adapter Style Connector.

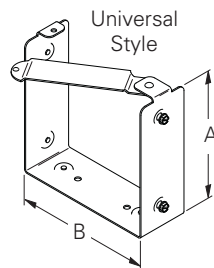
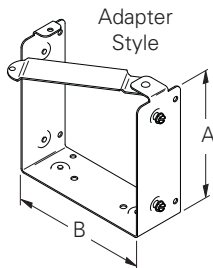
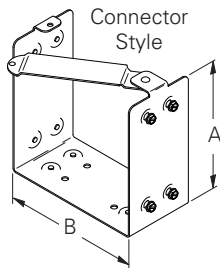

Connector

Swing gate allows for lay-in of wire and cable.

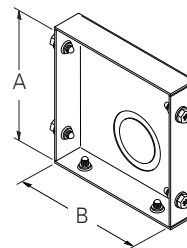

End

Used to terminate wireway or fitting. Shown with KO, also available without.

Drawing shows screws in place. Screws are actually packaged in plastic bags.

Connector

Catalog Number			A		B	
Connector Style	Adapter Style	Universal Style	in.	mm	in.	mm
22 HSC	22 HSCA	22 HSCU	2.50	63	2.50	63
44 HSC	44 HSCA	44 HSCU	4.00	102	4.00	102
66 HSC	66 HSCA	66 HSCU	6.00	152	6.00	152
88 HSC	88 HSCA	88 HSCU	8.00	203	8.00	203
1010 HSC	1010 HSCA	1010 HSCU	10.00	254	10.00	254
1212 HSC	1212 HSCA	1212 HSCU	12.00	305	12.00	305

HSC - Standard Quick Connector
HSCA - For adapting to Type 1 Screw Cover Wireway
HSCU - For adapting to competitive Wireway

End

Catalog Number		A		B		KO	
KO	No KO	in.	mm	in.	mm	in.	mm
22 HSE	22 HSE NK	2.50	63	2.50	63	1.50	38
44 HSE	44 HSE NK	4.00	102	4.00	102	1.50	38
66 HSE	66 HSE NK	6.00	152	6.00	152	1.50	38
88 HSE	88 HSE NK	8.00	203	8.00	203	1.50	38
1010 HSE	1010 HSE NK	10.00	254	10.00	254	3.00	76
1212 HSE	1212 HSE NK	12.00	305	12.00	305	3.00	76

Notes: Dimensions are in inches. Millimeters shown are for reference only. Data subject to change without notice.

Lay-In Wireway Type 1 Quick-Connect Hinge Cover Illustration Sheet and Catalog Number

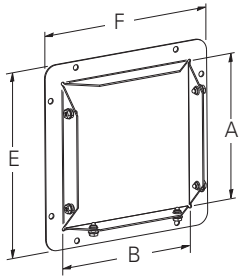

Wireway End Flange

Allows for a secure connection of wireway to an adjoining enclosure or wall.

Wireway End Flange

Catalog Number	A		B		E		F	
	in.	mm	in.	mm	in.	mm	in.	mm
22 HSF	2.50	63	2.50	63	4.00	102	4.00	102
44 HSF	4.00	102	4.00	102	5.50	140	5.50	140
66 HSF	6.00	152	6.00	152	7.50	191	7.50	191
88 HSF	8.00	203	8.00	203	9.50	241	9.50	241
1010 HSF	10.00	254	10.00	254	11.50	292	11.50	292
1212 HSF	12.00	305	12.00	305	13.50	343	13.50	343

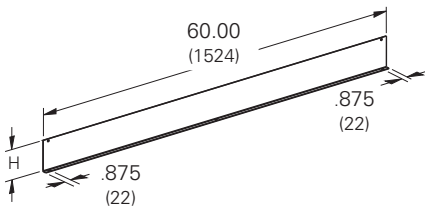

Barrier, Bolt-On

For those installations that require separate wiring compartments.

Barrier Kit, 60" Bolt-On

Catalog Number	Size		Length		H	
	in.	mm	in.	mm	in.	mm
22-12BK*	2.50 x 2.50	64 x 64	60.00	1524	1.88	48
33-12BK*	3.00 x 3.00	76 x 76	60.00	1524	2.25	57
44-12BK*	4.00 x 4.00	102 x 102	60.00	1524	3.00	76
66-12BK*	6.00 x 6.00	152 x 152	60.00	1524	4.50	114
88-12BK*	8.00 x 8.00	203 x 203	60.00	1524	6.00	152
1010-12BK*	10.00 x 10.00	254 x 254	60.00	1524	8.00	203
1212-12BK*	12.00 x 12.00	305 x 305	60.00	1524	10.50	267

*Not UL or CSA listed fitting.

Subclass: HS1

Wireway Hangers

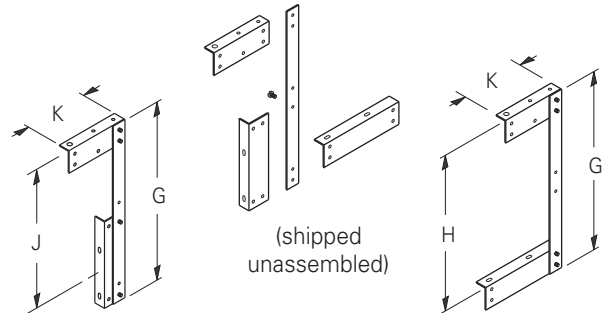

Side Cover Assembly

For those installations where the wireway cover must be hinged at the side.

Top Cover Assembly

For those installations where the wireway cover must be hinged at the top.

Wireway Hanger

Catalog Number	G		H		J		K	
	in.	mm	in.	mm	in.	mm	in.	mm
22 FH	8.50	216	8.50	216	6.50	165	2.87	73
44 FH	12.50	318	10.50	267	10.37	263	4.87	121
66 FH	16.50	419	14.50	394	13.50	340	5.87	146
88 FH	20.50	521	18.50	495	16.75	425	6.87	171
1010 FH **	24.50	622	22.50	571	17.25	438	7.87	200
1212 FH **	28.50	724	26.50	673	20.25	514	8.87	225

** Hangers are shipped welded in the top cover assembly position.

Notes: Dimensions are in inches. Millimeters shown are for reference only. Data subject to change without notice.

Lay-In Wireway Type 1 Quick-Connect Hinge Cover Illustration Sheet and Catalog Number

Subclass: HS1

Wireway 90° Elbows

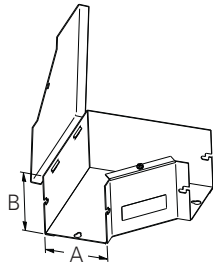
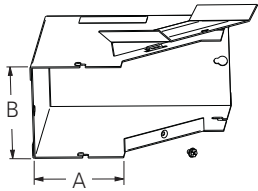

Inside Opening

Specifically designed to have only the inside cover hinge open to allow a continuous run with 90° turns.

Side Opening

Side cover is hinged to allow a continuous run on designs with 90° sweeping turns.

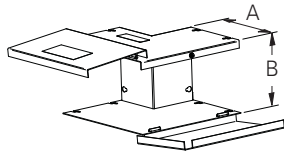

Outside Opening

Specifically designed to have the outside covers hinge open to allow a continuous run with 90° turns.

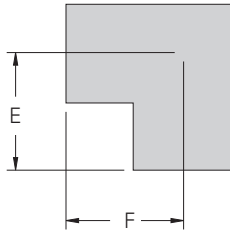

(outside opening)

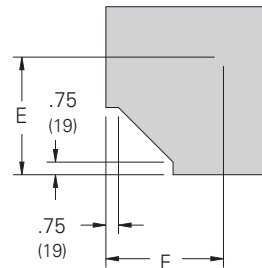

(inside and side opening)

Catalog Number	A		B		E		F	
	in.	mm	in.	mm	in.	mm	in.	mm
22 HSL IN	2.50	63	2.50	63	3.31	84	3.31	84
44 HSL IN	4.00	102	4.00	102	4.06	103	4.06	103
66 HSL IN	6.00	152	6.00	152	5.06	128	5.06	128
88 HSL IN	8.00	203	8.00	203	6.06	154	6.06	154
1010 HSL IN	10.00	254	10.00	254	7.06	179	7.06	179
1212 HSL IN	12.00	305	12.00	305	8.06	205	8.06	205
22 HSL OUT	2.50	63	2.50	63	3.38	86	3.38	86
44 HSL OUT	4.00	102	4.00	102	4.09	104	4.09	104
66 HSL OUT	6.00	152	6.00	152	5.09	129	5.09	129
88 HSL OUT	8.00	203	8.00	203	6.09	154	6.09	154
1010 HSL OUT	10.00	254	10.00	254	7.09	180	7.09	180
1212 HSL OUT	12.00	305	12.00	305	8.09	205	8.09	205
22 HSL SIDE	2.50	63	2.50	63	3.50	89	3.50	89
44 HSL SIDE	4.00	102	4.00	102	4.32	110	4.32	110
66 HSL SIDE	6.00	152	6.00	152	5.31	135	5.31	135
88 HSL SIDE	8.00	203	8.00	203	6.31	160	6.31	160
1010 HSL SIDE	10.00	254	10.00	254	7.31	185	7.31	185
1212 HSL SIDE	12.00	305	12.00	305	8.31	211	8.31	211

Wireway 45° Elbows

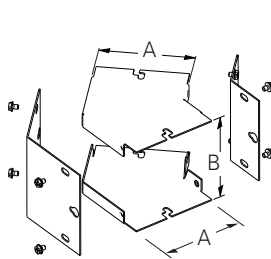

Combo Opening

Designed to achieve a 45° turn. Inside and outside removable covers are secured with screws.

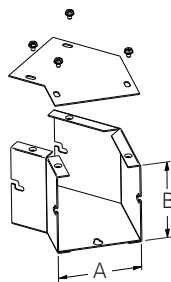

Side Opening

Designed to achieve a 45° turn and have the cover removed from the side. Excellent for combining two to make a gradual 90° sweep.

Catalog Number	A		B		E		F	
	in.	mm	in.	mm	in.	mm	in.	mm
2245 HSL COMBO	2.50	63	2.50	63	1.72	43	1.72	43
4445 HSL COMBO	4.00	102	4.00	102	2.75	70	2.75	70
6645 HSL COMBO	6.00	152	6.00	152	3.18	81	3.18	81
8845 HSL COMBO	8.00	203	8.00	203	3.62	92	3.62	92
101045 HSL COMBO	10.00	254	10.00	254	4.06	103	4.06	103
121245 HSL COMBO	12.00	305	12.00	305	4.50	114	4.50	114
2245 HSL SIDE	2.50	63	2.50	63	1.72	43	1.72	43
4445 HSL SIDE	4.00	102	4.00	102	2.75	70	2.75	70
6645 HSL SIDE	6.00	152	6.00	152	3.18	81	3.18	81
8845 HSL SIDE	8.00	203	8.00	203	3.62	92	3.62	92
101045 HSL SIDE	10.00	254	10.00	254	4.06	103	4.06	103
121245 HSL SIDE	12.00	305	12.00	254	4.50	114	4.50	114

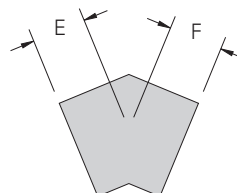

Notes: Dimensions are in inches. Millimeters shown are for reference only. Data subject to change without notice.

Lay-In Wireway Type 1 Quick-Connect Hinge Cover Illustration Sheet and Catalog Number

Subclass: HS1

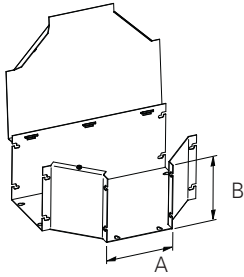

Tee
Side hinge cover design for applications where a "T" junction is necessary.

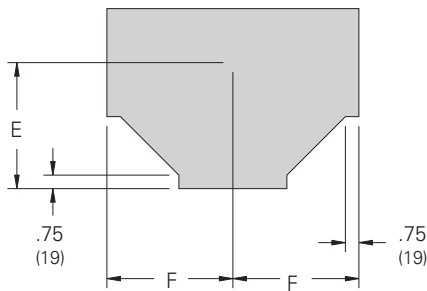

Catalog Number	Tee							
	A		B		E		F	
	in.	mm	in.	mm	in.	mm	in.	mm
22 HST	2.50	63	2.50	63	5.38	136	4.25	198
44 HST	4.00	102	4.00	102	6.15	156	6.12	155
66 HST	6.00	152	6.00	152	7.15	181	7.12	181
88 HST	8.00	203	8.00	203	8.15	207	8.12	206
1010 HST	10.00	254	10.00	254	9.15	232	9.12	231
1212 HST	12.00	305	12.00	305	10.15	258	10.12	257

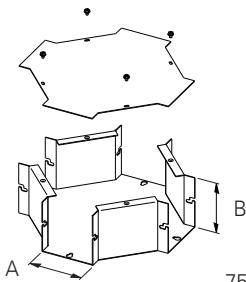

Cross
Side cover and broad body design to junction cable run in four directions. Removable cover is secured with screws.

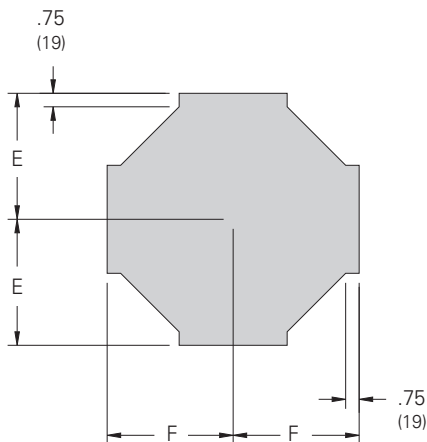

Catalog Number	Cross							
	A		B		E		F	
	in.	mm	in.	mm	in.	mm	in.	mm
22 HSX	2.50	63	2.50	63	5.97	151	5.97	151
44 HSX	4.00	102	4.00	102	6.75	171	6.75	171
66 HSX	6.00	152	6.00	152	7.75	197	7.75	197
88 HSX	8.00	203	8.00	203	8.75	222	8.75	222
1010 HSX	10.00	254	10.00	254	9.75	247	9.75	247
1212 HSX	12.00	305	12.00	305	10.75	273	10.75	273

Notes: Dimensions are in inches. Millimeters shown are for reference only. Data subject to change without notice.